

DIEBOLT

D 24 - 107 DT

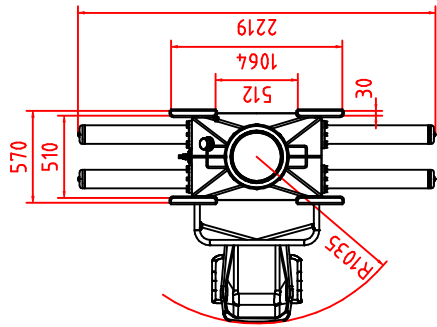
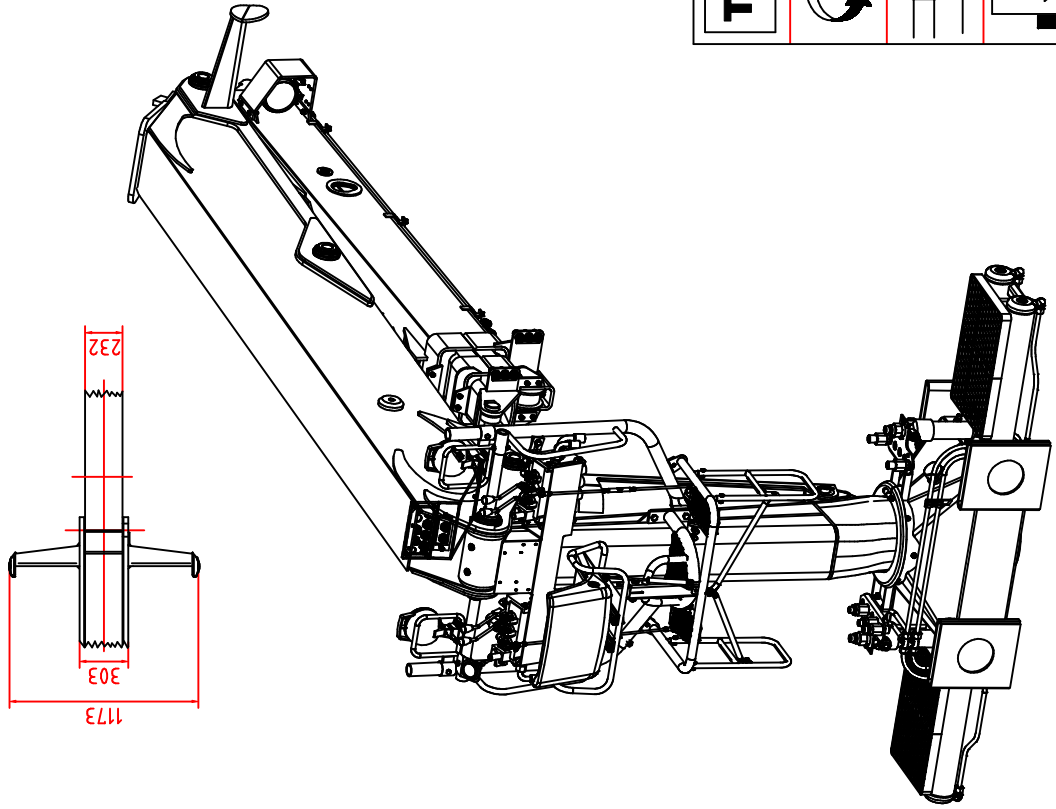
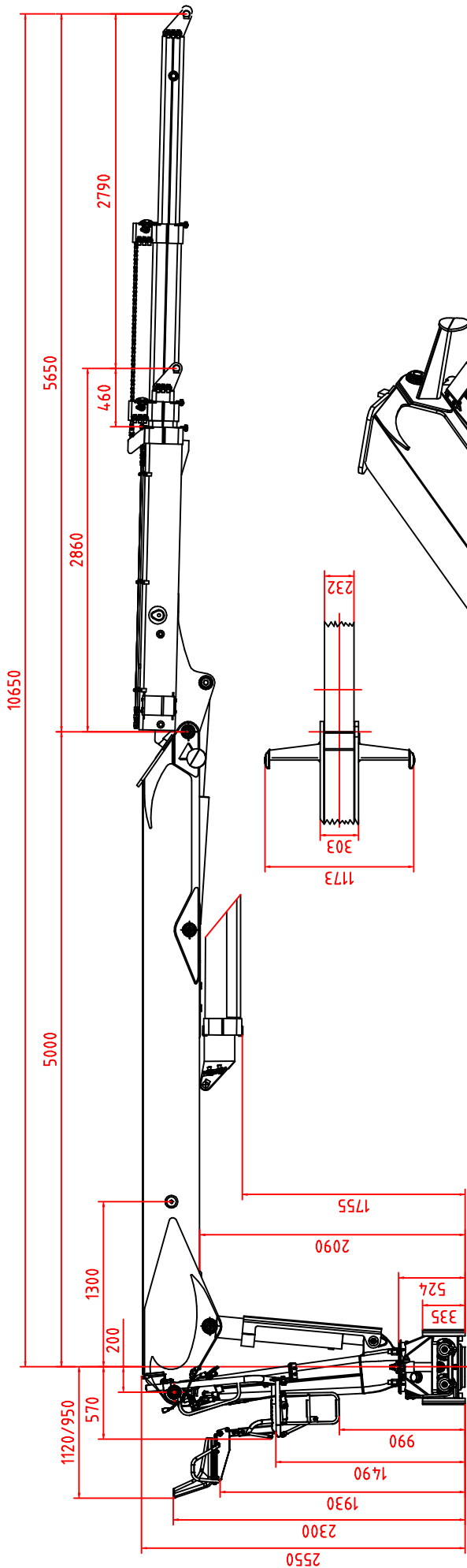

Tm	195 KNm	405°	10650 mm	25 MPa
Q	2x80 L/min	40 KNm	2790 mm	2600 Kg

Sous réserve de modifications techniques !
 Technische Änderungen vorbehalten !
 Technical modifications reserved !